



Quadrilla
Intelligent playing in wood

Instructions
Music Motion

Am Anfang war der Kreis ...

In the beginning, there was a circle...
Au début était le cercle
In het begin was er een cirkel
All'inizio era il cerchio

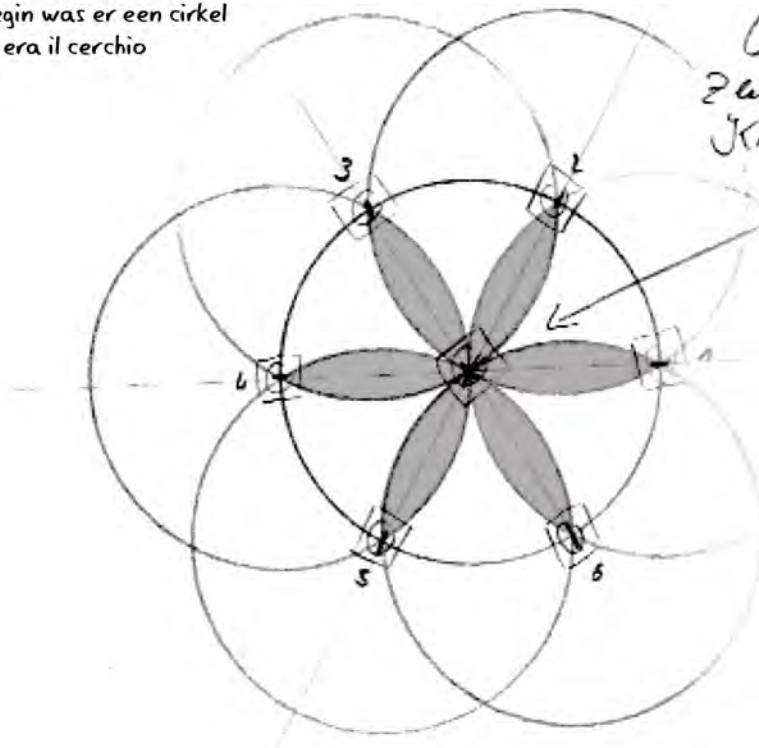

Quadrat im
Zentrum des
Kreises



560°

6 Scheitelpunkte
für Quadrate
am Äußeren Kreis

Grundprinzip der Kurvigen
Kugelbahnen v. Quadtilla



Top view of the
marble run.



This is how it works best:

The speeding up of the marbles on Quadrilla is achieved with different blocks and/or the small red accelerators. The tracks themselves always have to be level and must not be built with a gradient. The height of a track can be compensated with one purple riser.

Let your imagination run wild and enjoy the game!



So klappt's am besten:

Die Beschleunigung der Murmeln auf der Quadrilla Kugelbahn wird über die unterschiedlichen Quader und/oder den kleinen roten Beschleuniger erzielt. Die Schienen müssen immer waagrecht aufgebaut werden! Die Höhe der Schiene kann im Aufbau mit einer lilafarbenen Platte ausgeglichen werden. Lasst eurer Fantasie freien Lauf. Viel Spaß beim Spielen!



Voici le meilleur fonctionnement:

L'accélération des billes sur le Quadrilla est réalisée avec différents blocs et/ou petits accélérateurs rouges. Les voies elles-mêmes doivent toujours être de niveau et ne doivent pas être construites en pente. La taille d'une voie peut être compensée par un élément mauve.

Laissez galoper votre imagination et amusez-vous!

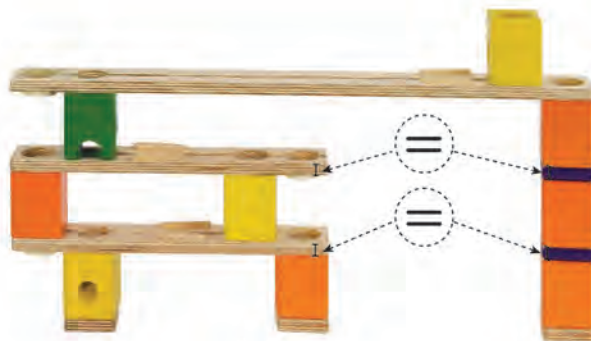

Betere Werking:

Het versnellen van de knikkers op Quadrilla wordt bereikt met verschillende blokken en/of de kleine rode versnellers. De sporen zelf moeten altijd op gelijke hoogte zijn en mogen niet met een helling worden gebouwd. De hoogte van een spoor kan met één paars element worden gecompenseerd. Laat uw verbeelding werken en geniet van het spelletje!

Come funziona meglio:

L'accelerazione delle biglie in Quadrilla è realizzata grazie ai diversi blocchi e alle rampe esistenti. Nel montare i diversi binari osserva che siano sempre alla stessa altezza per garantire una certa stabilità. L'altezza di un binario può essere compensata da un elemento color porpora. È adesso spazio alla tua fantasia e divertiti!

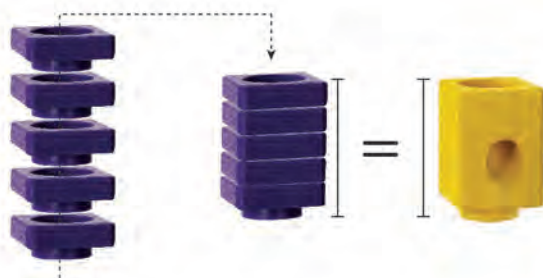



Contents of this set

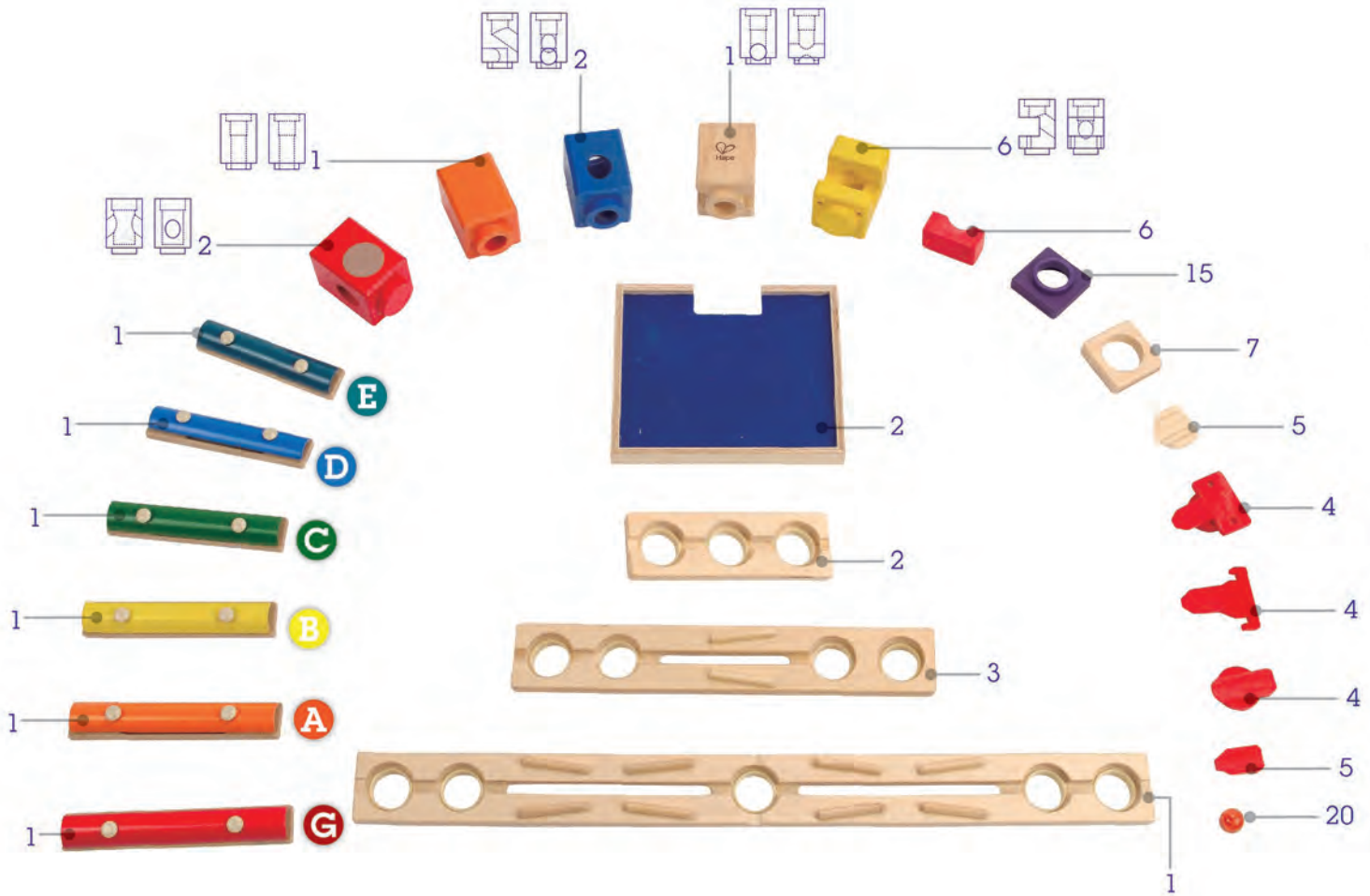

1

Music Motion

5

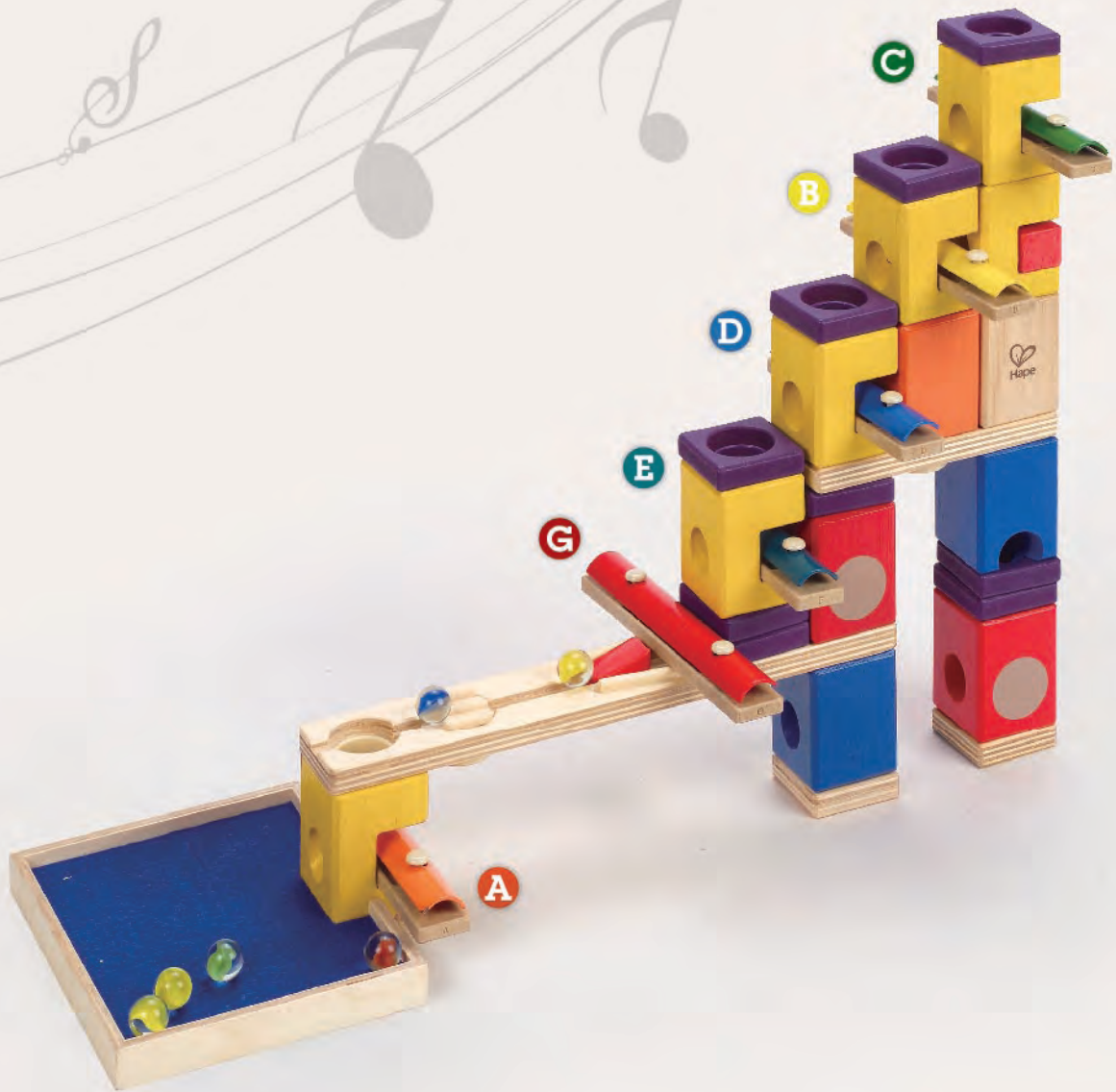

A

G

E

D

B

C

1



2



3

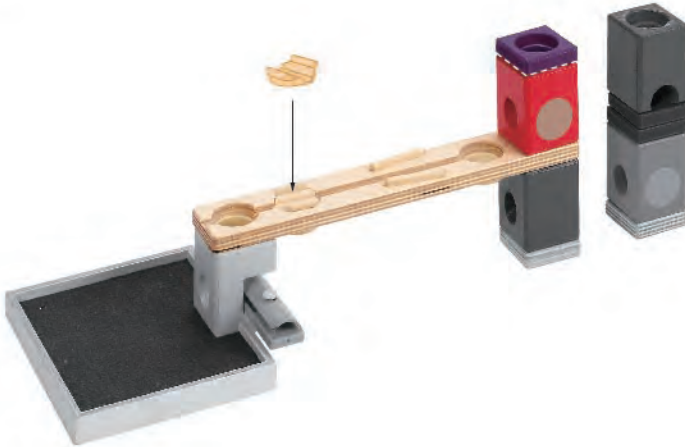

6

4

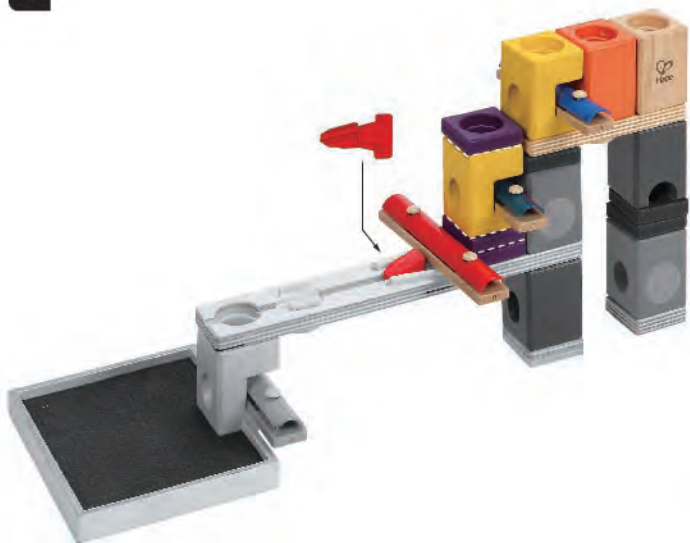

5



Don't forget to put...



And here we go !

7

2

Music Motion



1

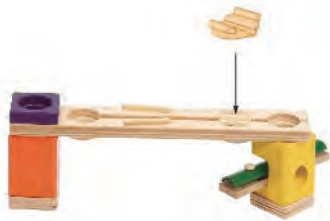

2

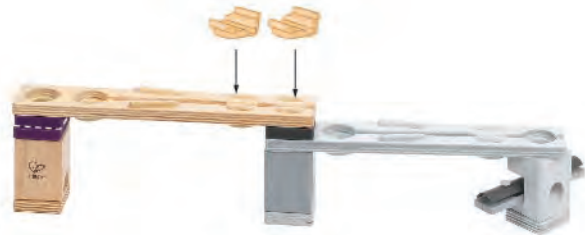

6

3

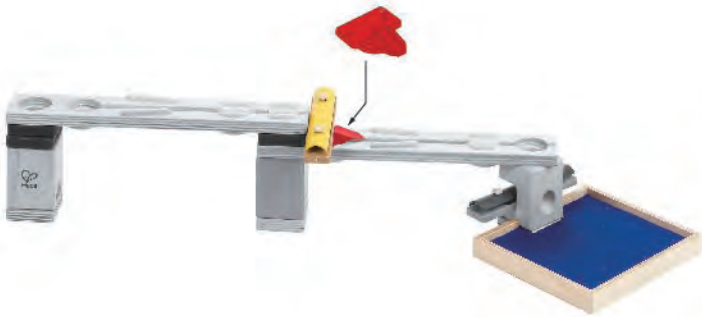

4

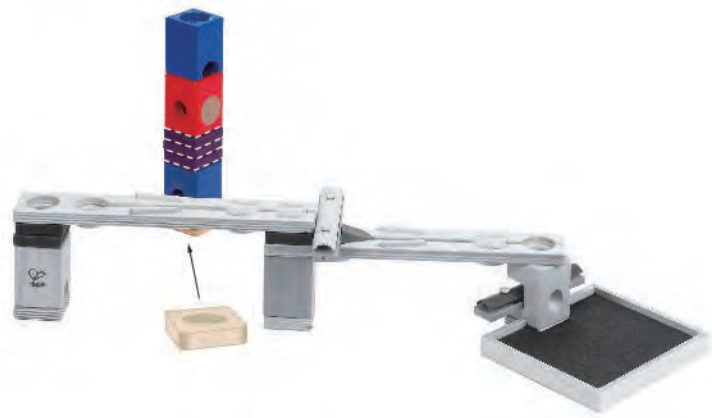

5

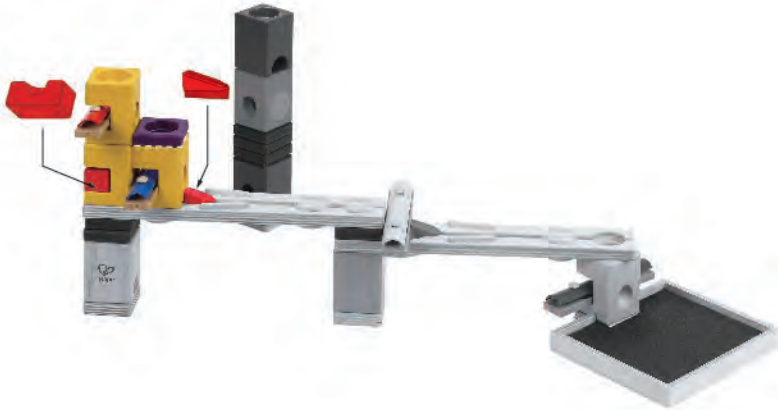

Don't forget to put...



And here we go !

6



3

Music Motion

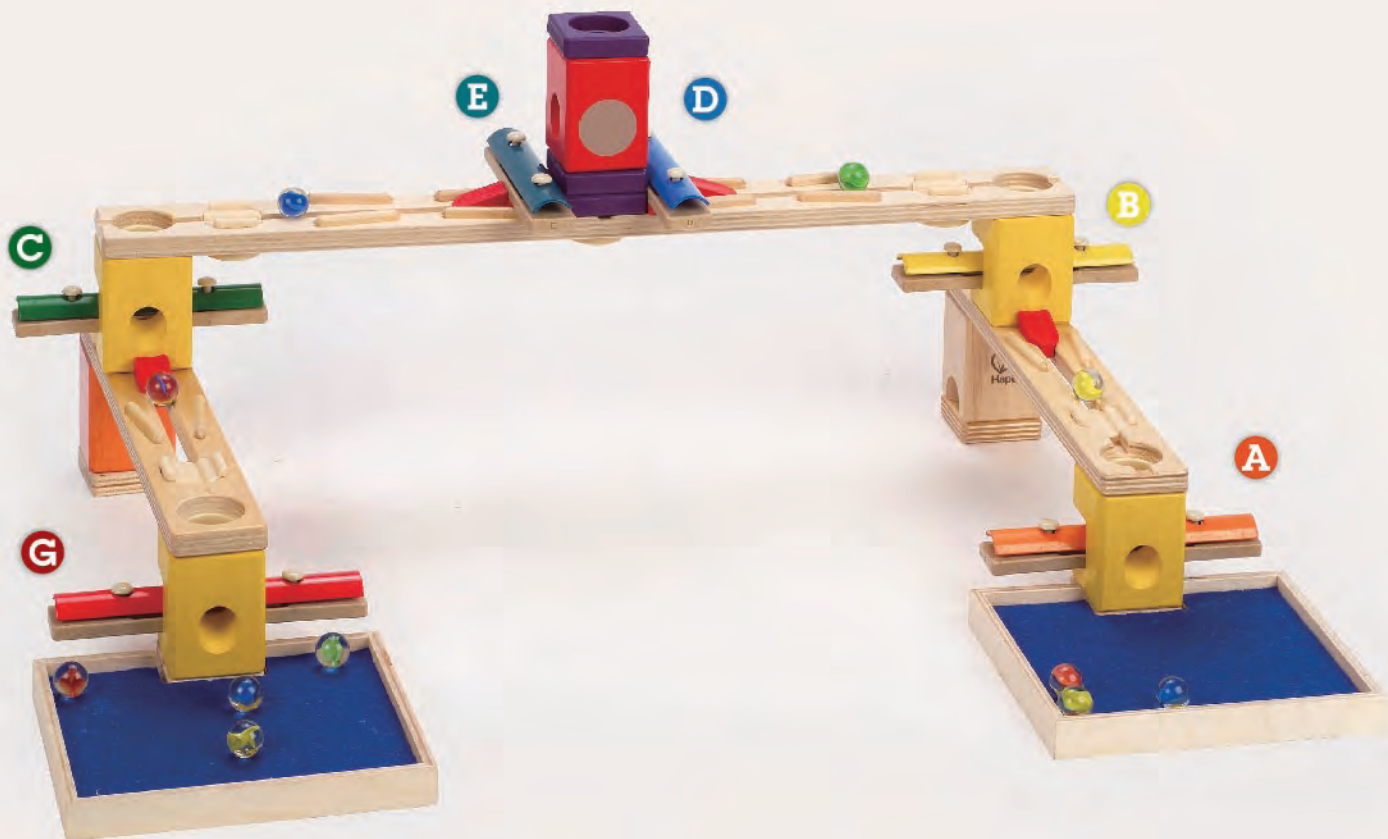

1

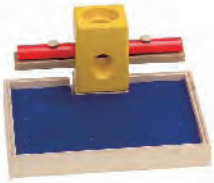

2

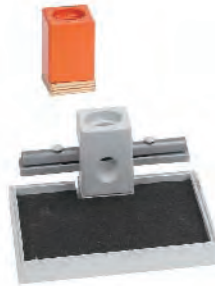

3



4

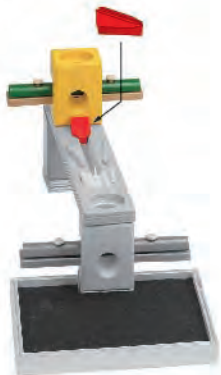

5

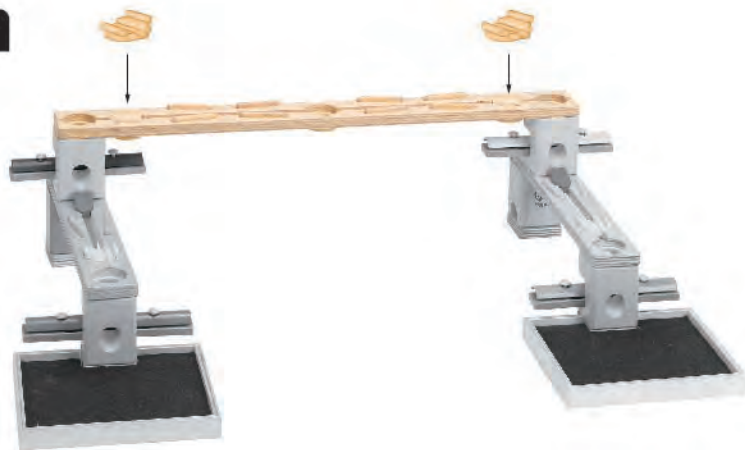

6

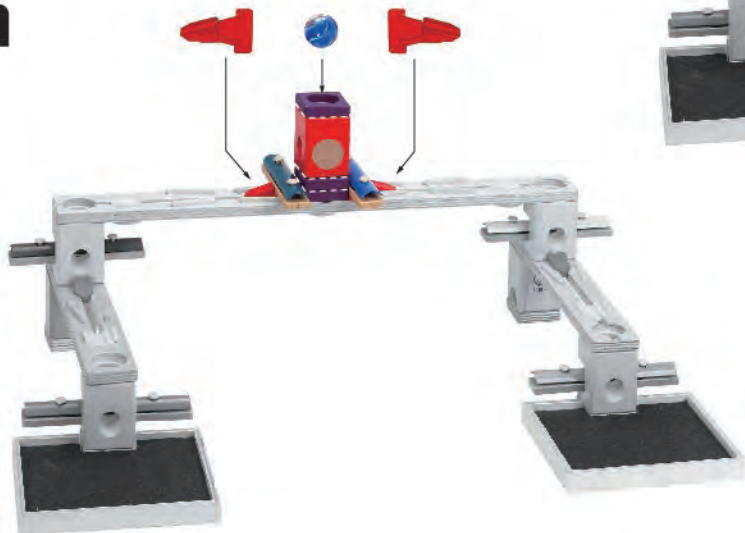

Don't forget to put...



And here we go !

4

Music Motion



1

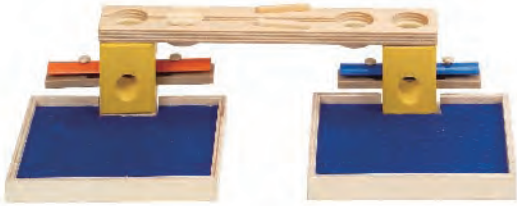

2

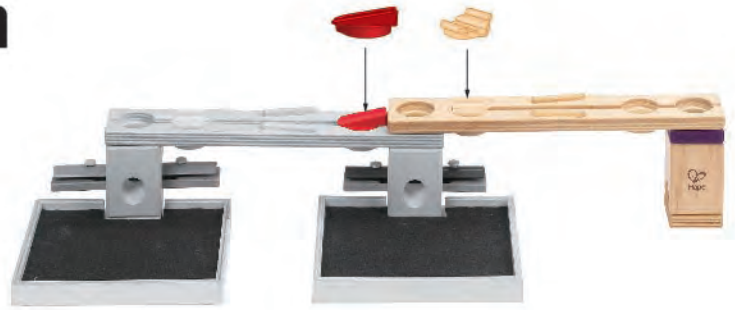

3



4

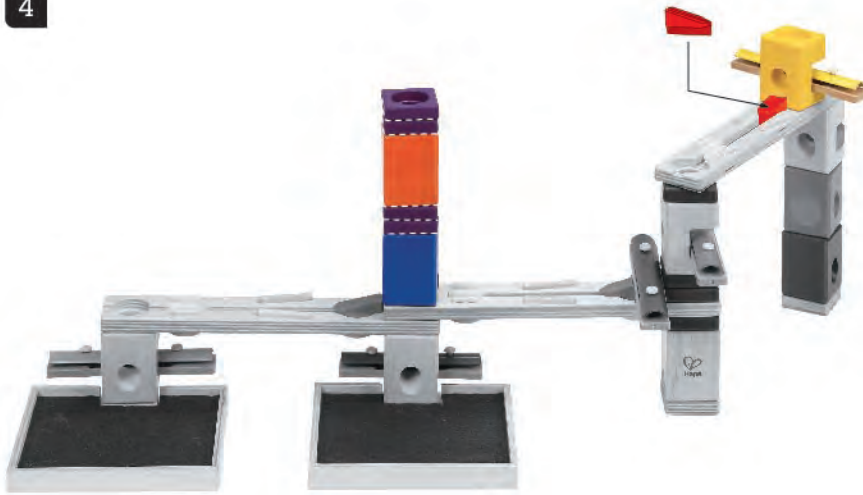

5

Don't forget to put...

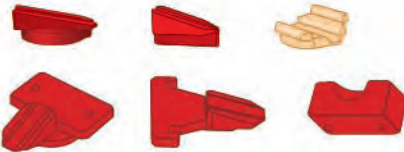

And here we go !



5

Music Motion

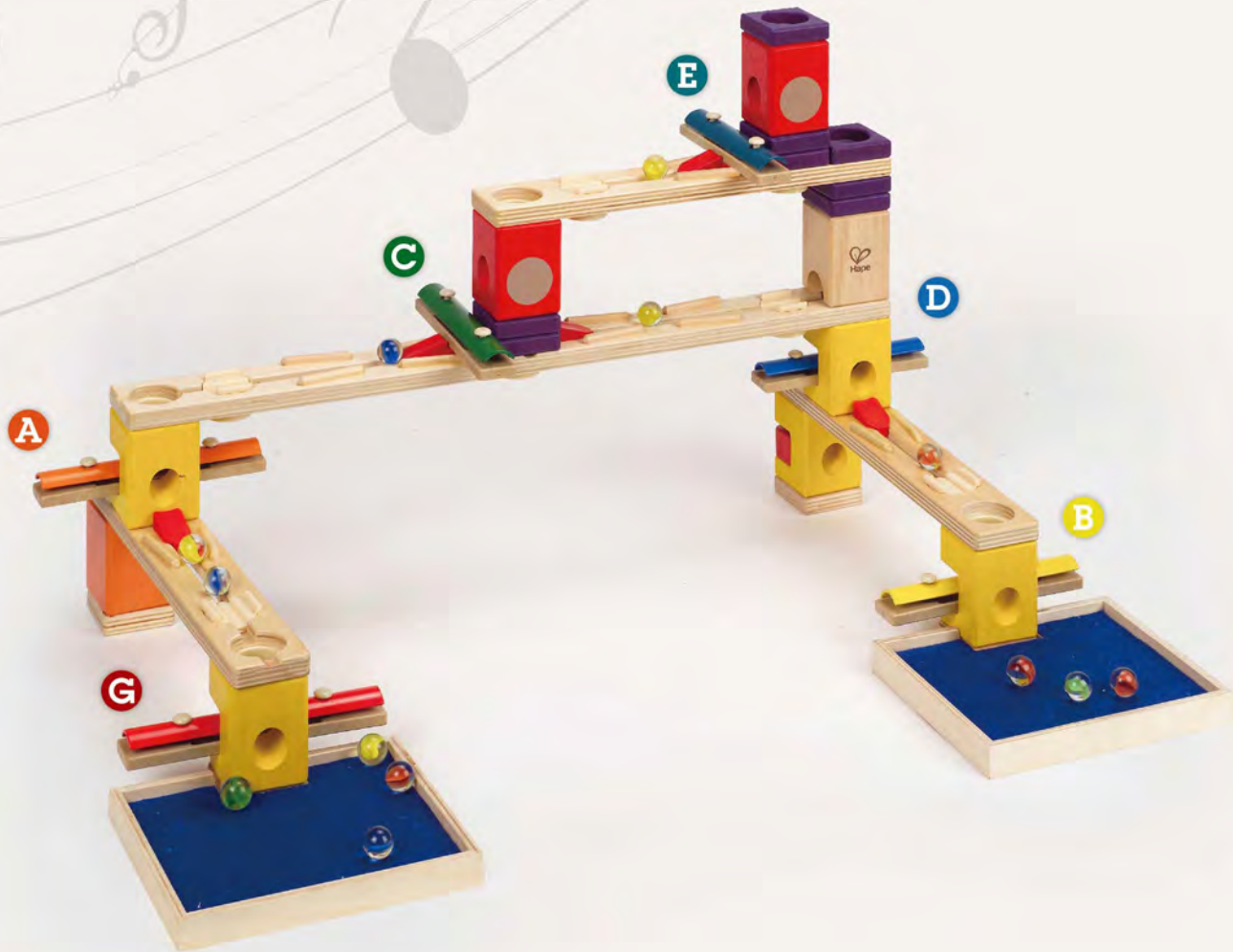

1



2

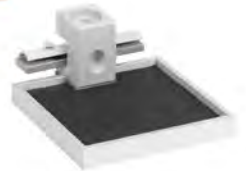

3

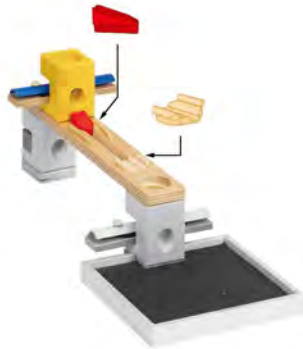
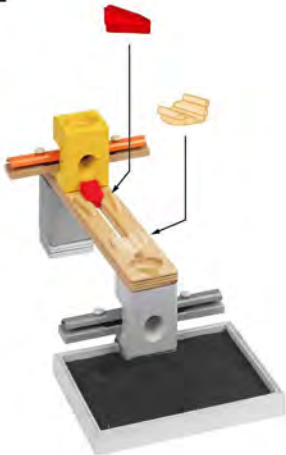

4

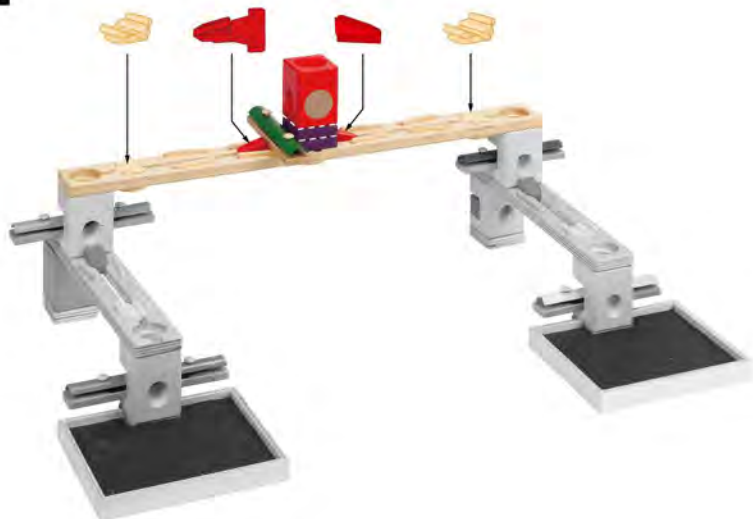

5



Don't forget to put...

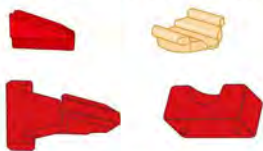

And here we go !

6

Music Motion

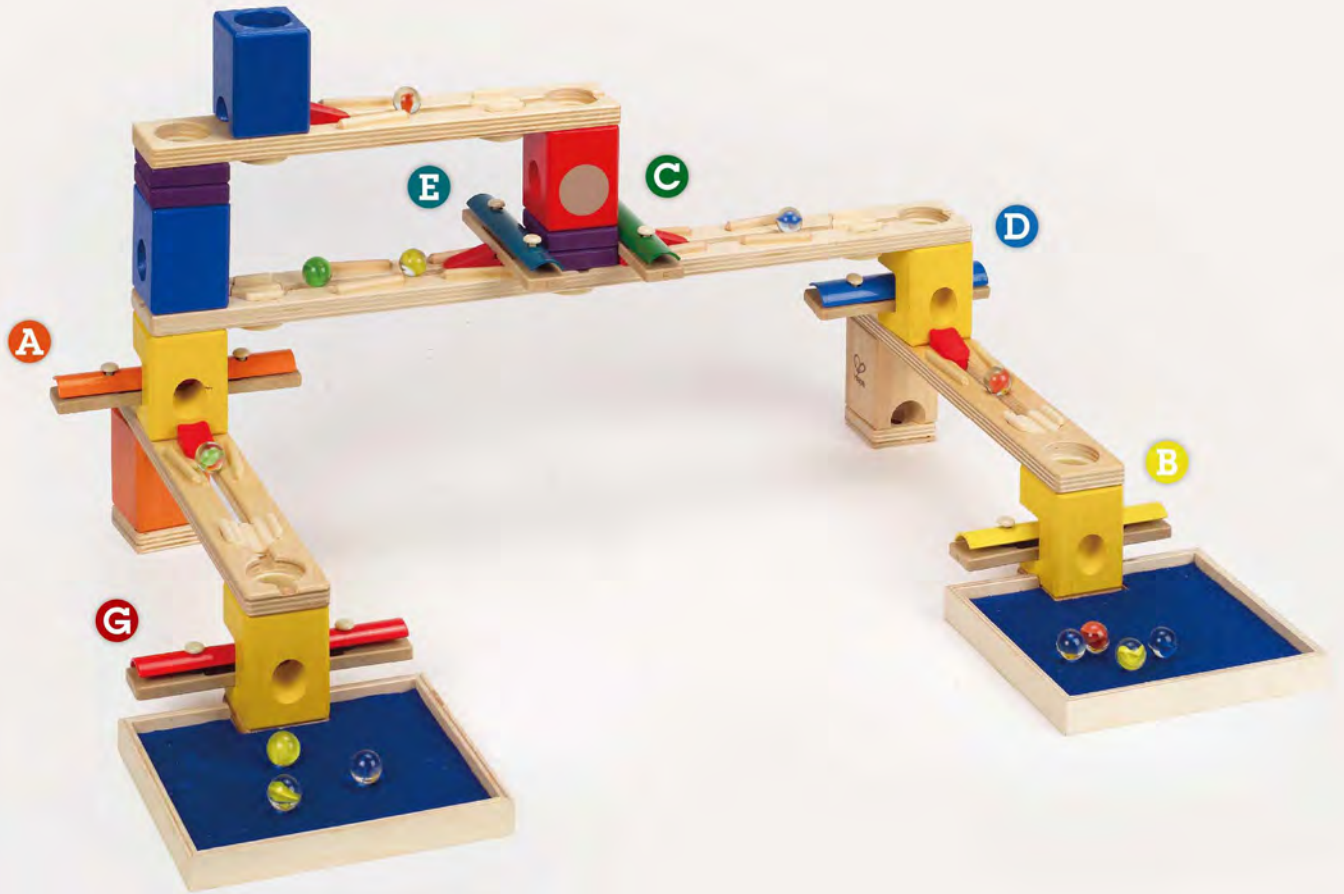

1



2



3

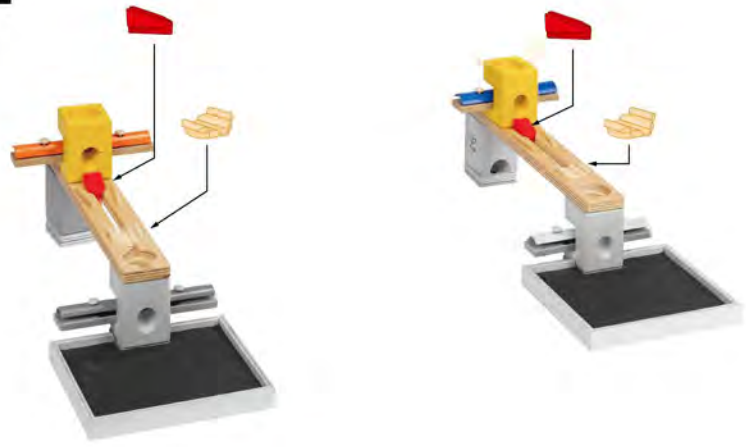

4

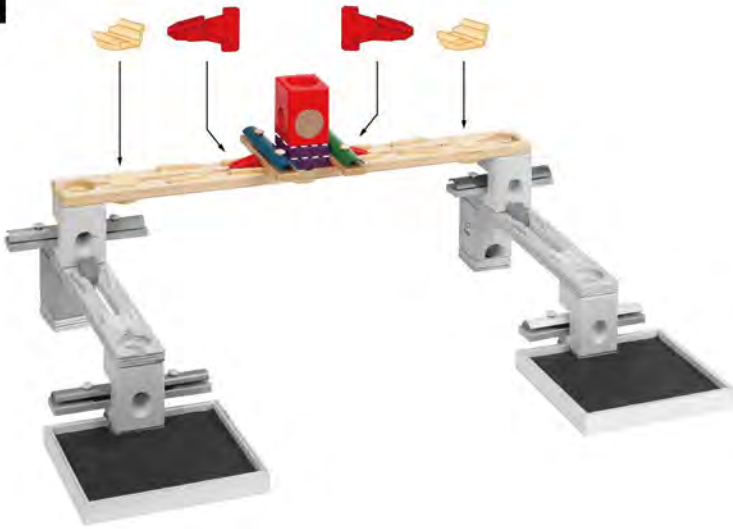

5

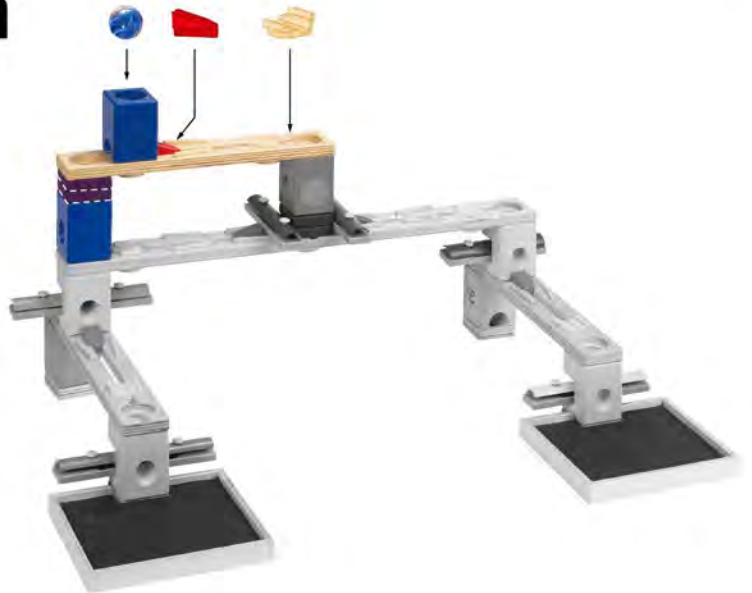

Don't forget to put...



And here we go !

7

Music Motion



1



2

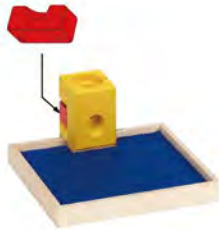

3



4

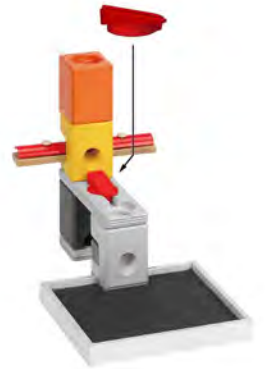
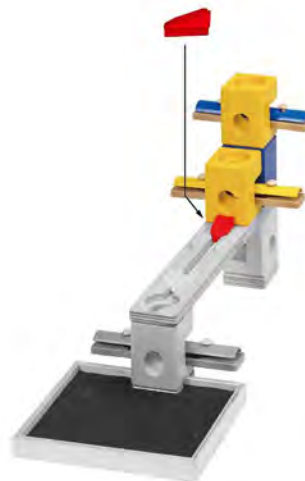

5



6



Don't forget to put...



And here we go !

8

Music Motion

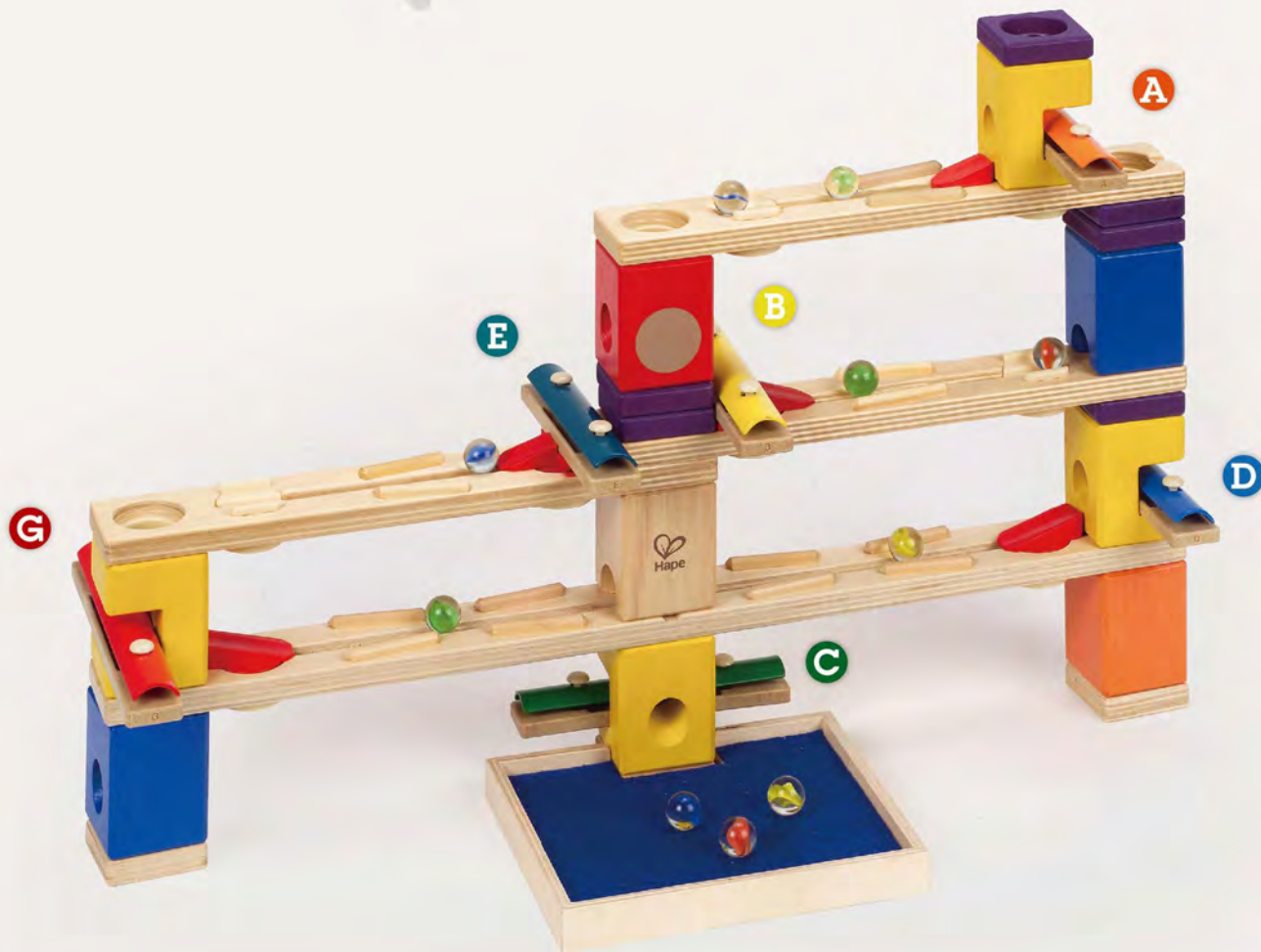

1



2



3



4

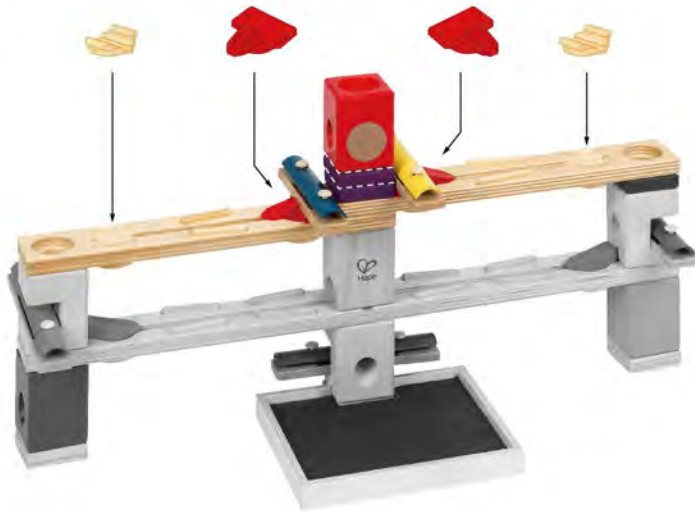

5



28

Don't forget to put...



And here we go !



1



2

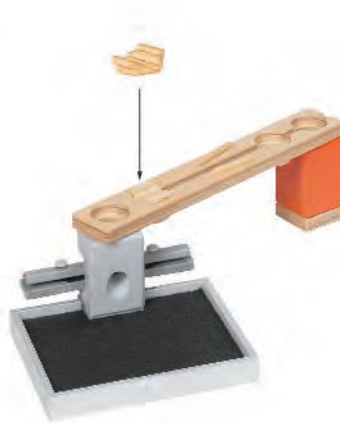

3

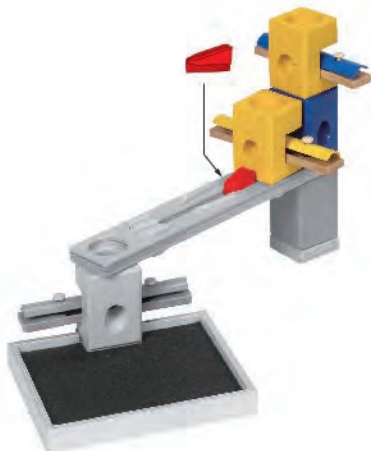

4



5



Don't forget to put...

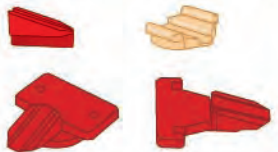

And here we go !

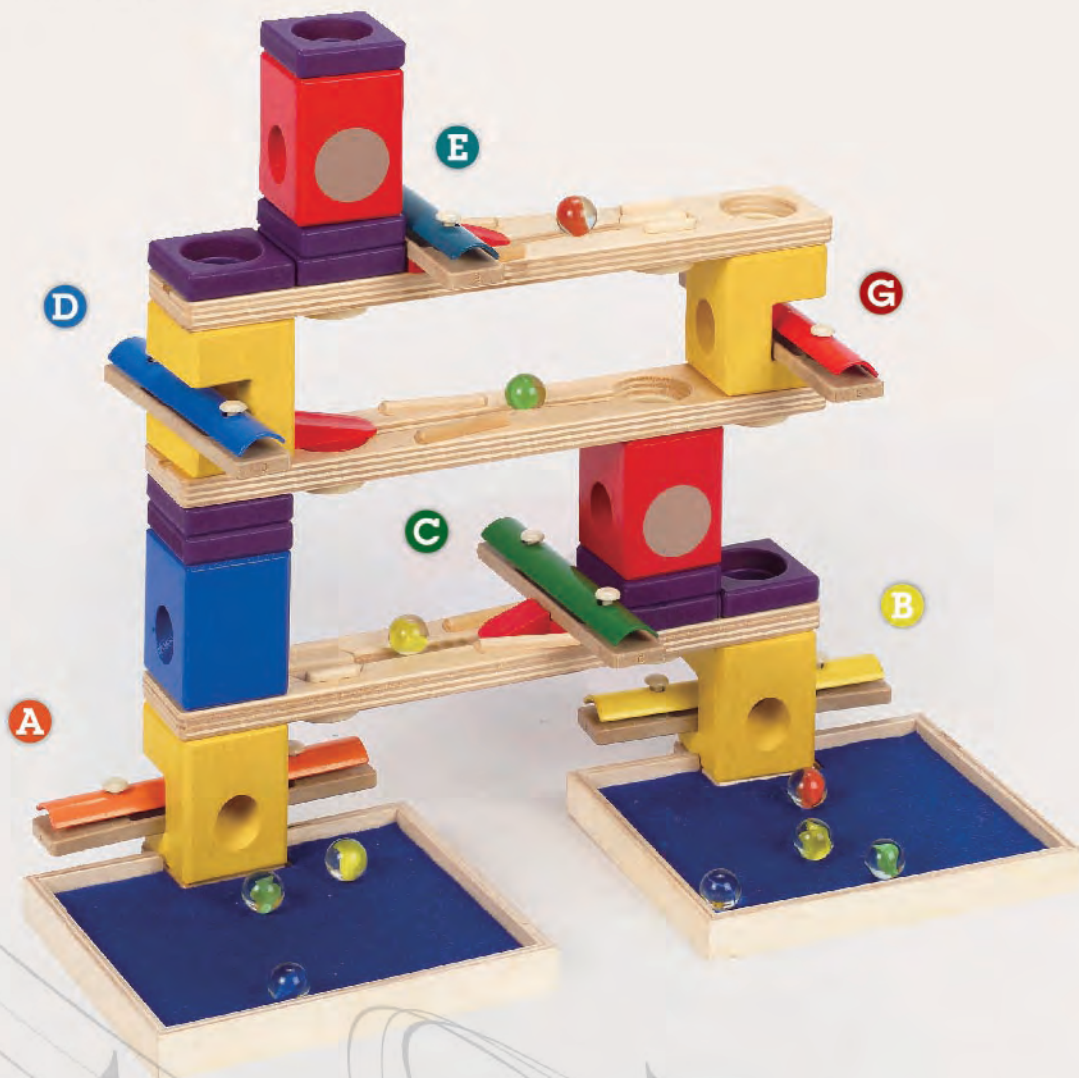

1

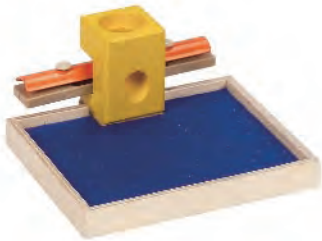

2

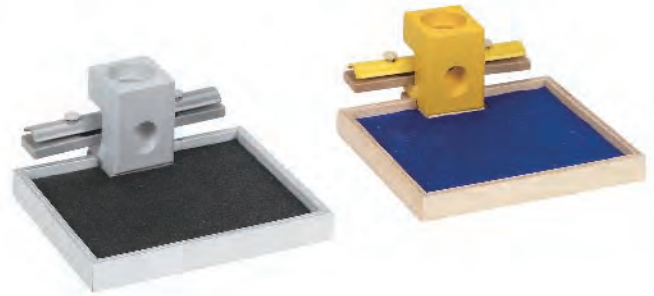

3

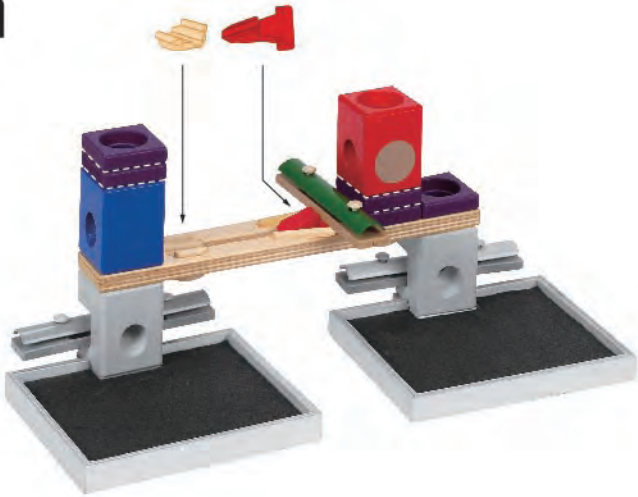

4

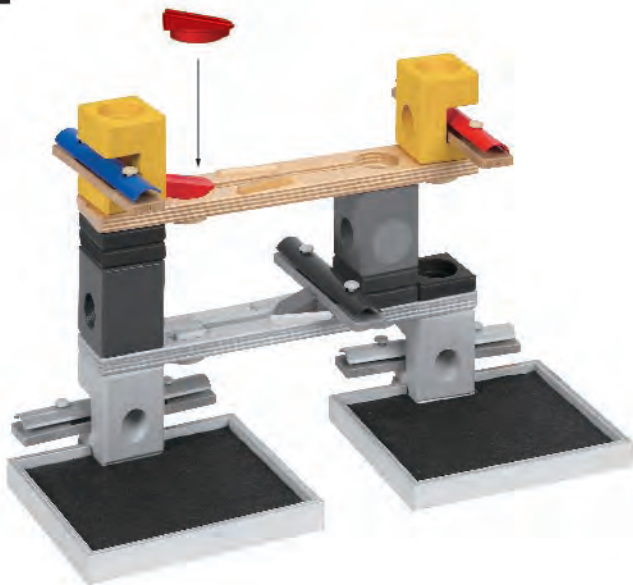

5

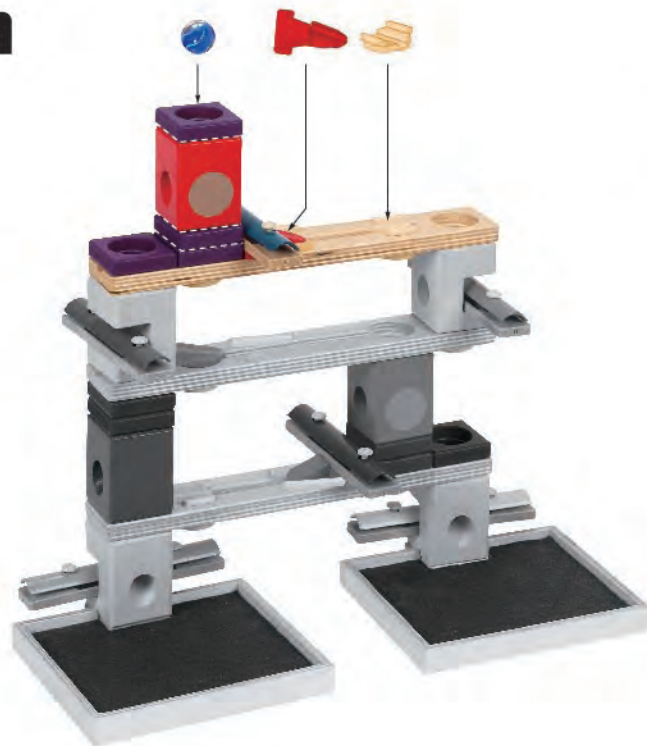

Don't forget to put...



And here we go !

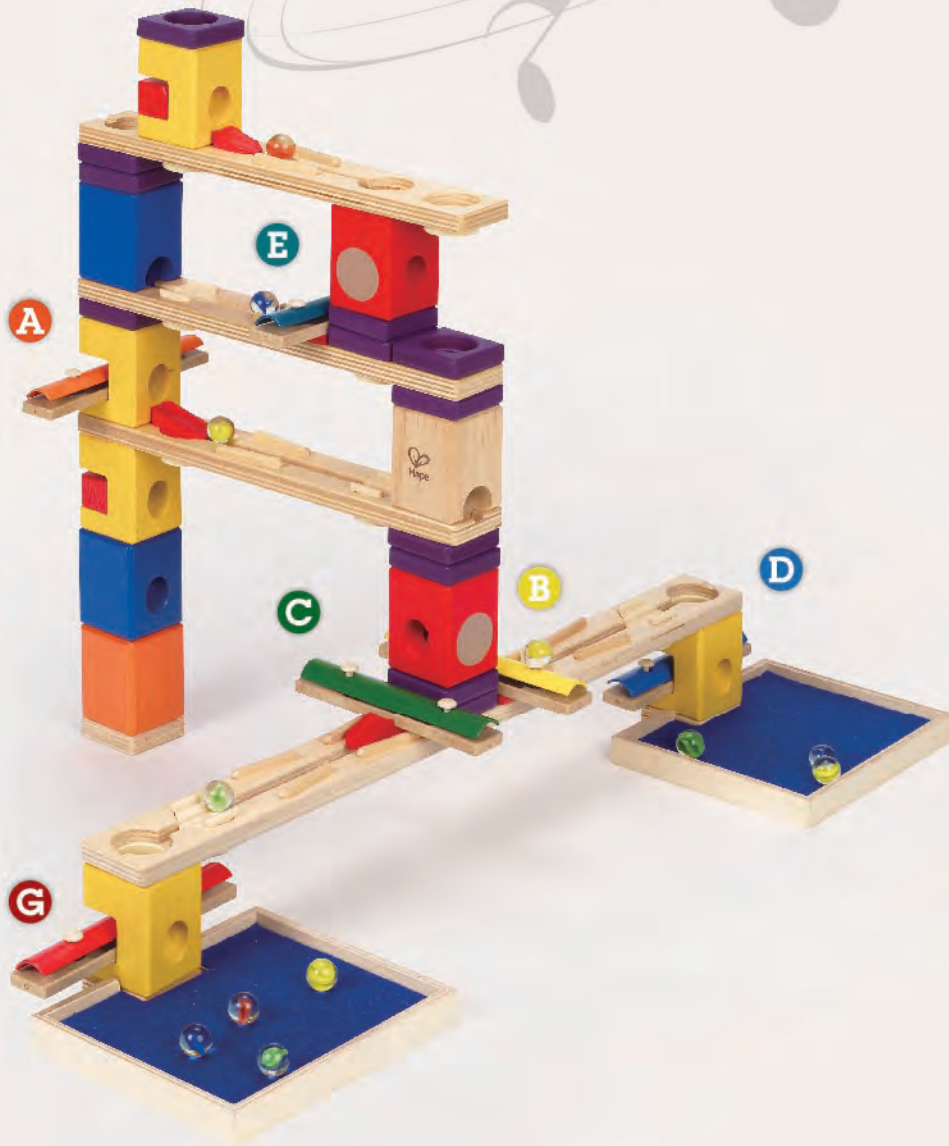

1



2

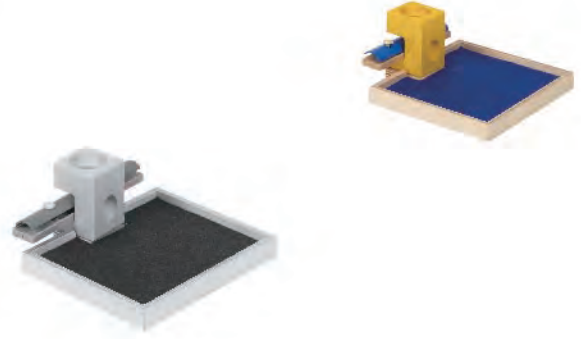

3

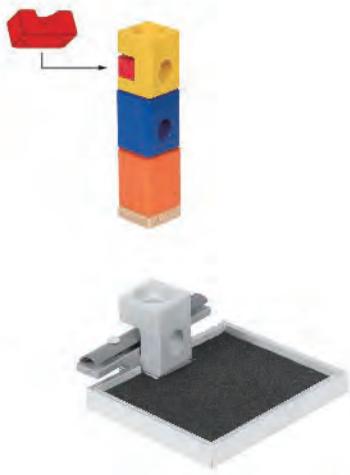

4

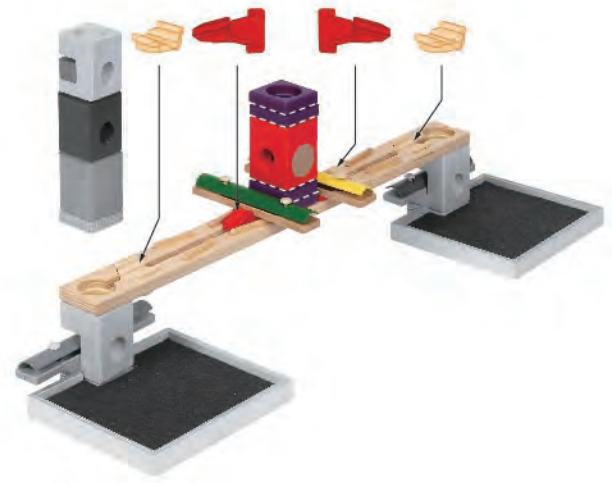

5

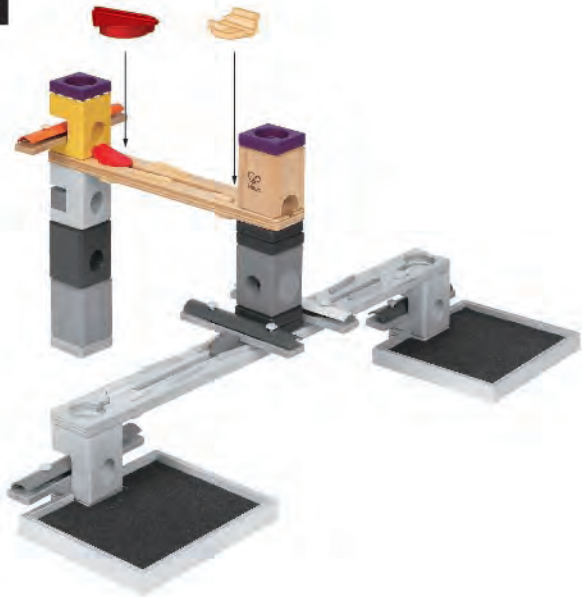

6



Don't forget to put...



And here we go !

12 Music Motion

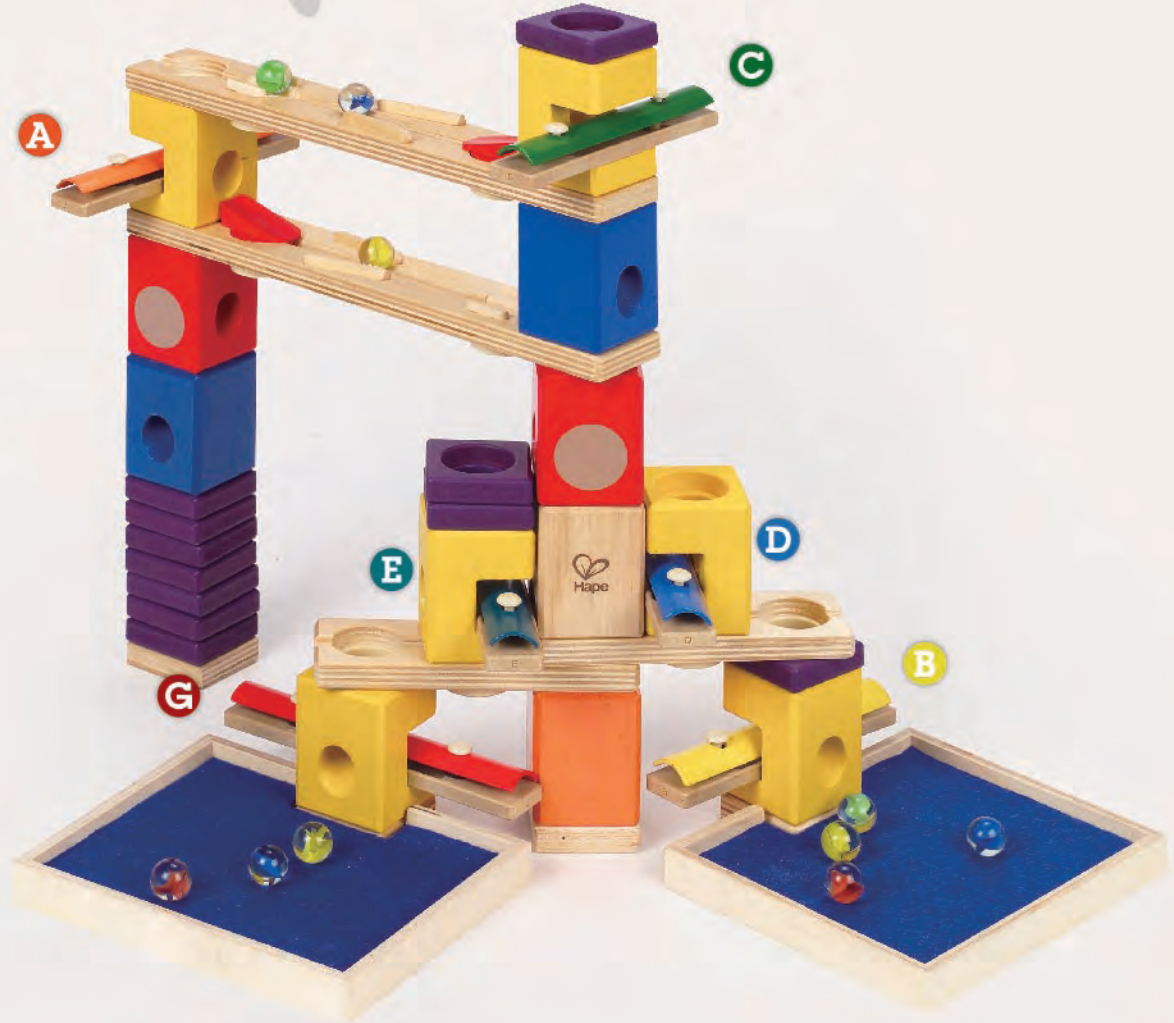

1

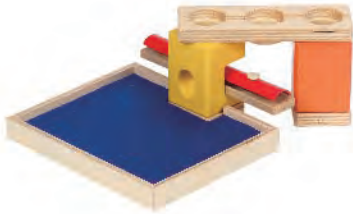

2

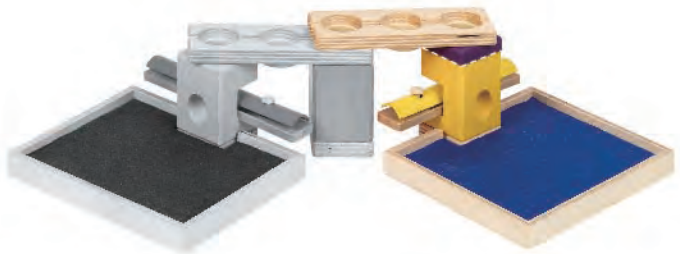

3

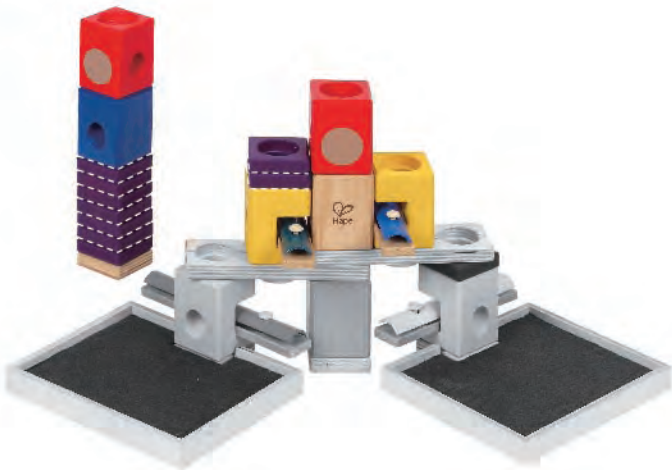

4

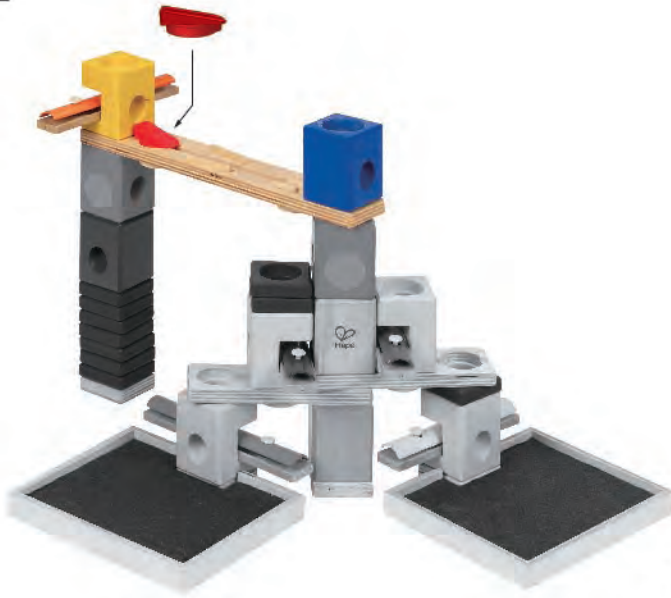

Don't forget to put...



And here we go !

5



1



2



1

E6005
The Roundabout

2

E6006
Autobahn



3
E6007
Xcellerator



4
E6008
The Cyclone

5



5

E6009
Vertigo

★ 6

E6012
Music Motion

6



7

E6013
Whirlpool



8

E6014
Loop de Loop



Tips and tricks:

you can get new construction ideas and information at:
www.quadrilla.com

Tipps und Tricks:

die neusten Aufbautipps und weitere Informationen erhaltet ihr unter: www.quadrilla.de

Tuyaux et trucs:

vous pouvez obtenir des nouvelles idées de construction et des informations sur:
www.quadrilla.com

Tips en trucjes:

u kunt nieuwe bouwideeën en informatie verkrijgen via: www.quadrilla.com

Astuzie e trucchi:

per ulteriori informazioni e nuove idee di costruzione visita: www.quadrilla.com

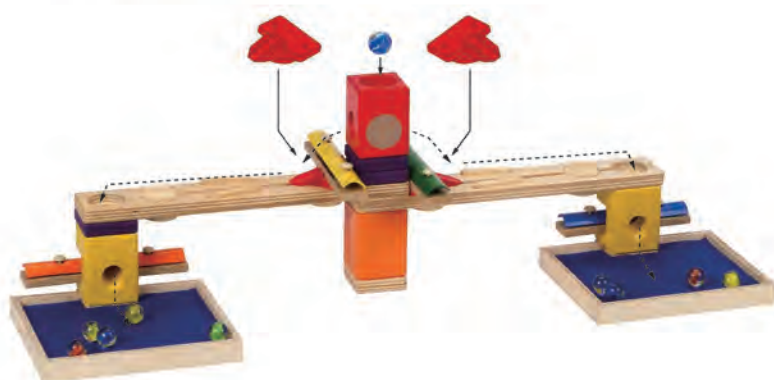
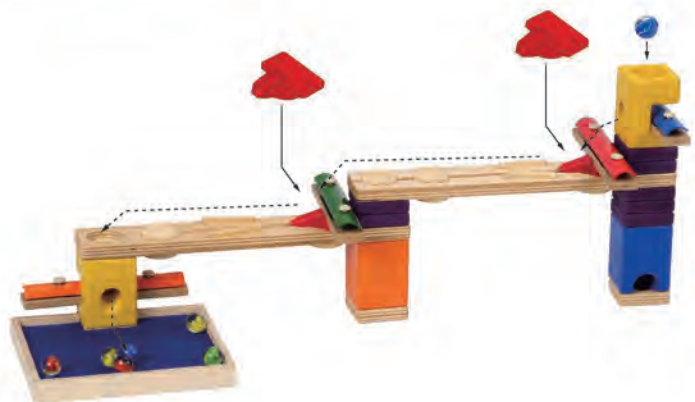
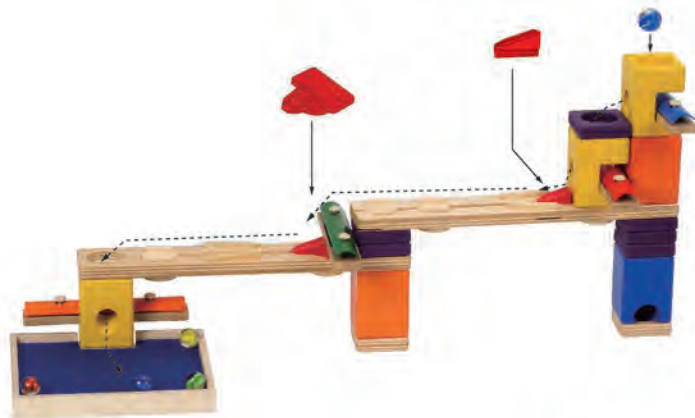

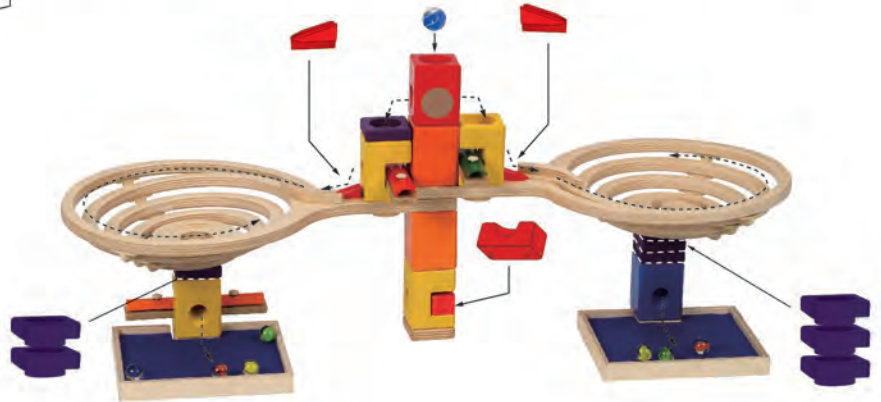
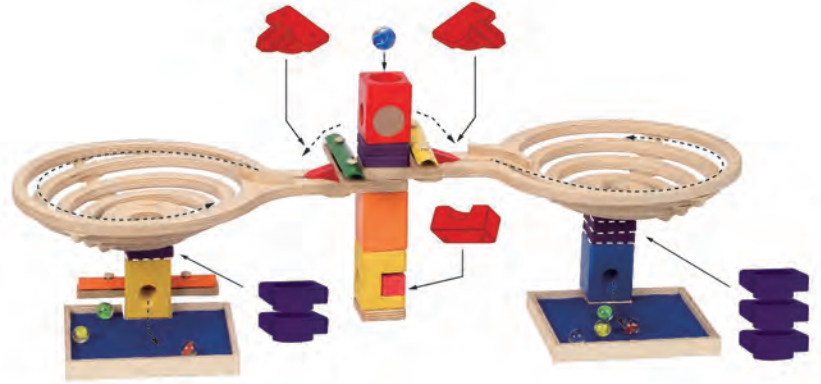
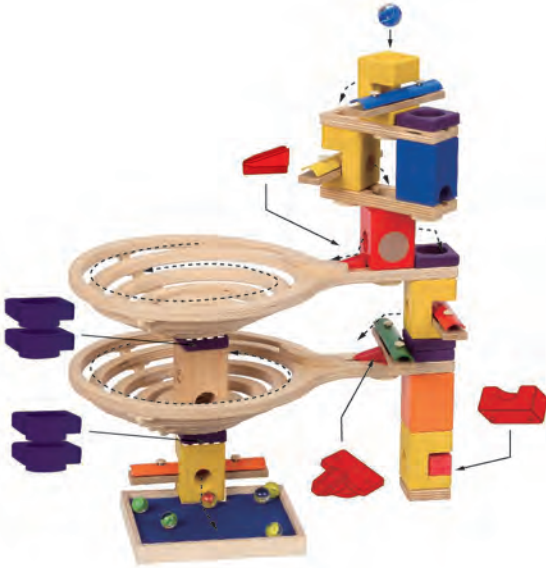



Manufactured by Hape
Hallwilerweg 2, 6003 Luzern
Switzerland
www.hapetoys.com

Hape
123 Cree Road
Sherwood Park AB
Canada T8A 3X9
www.hapetoys.com
info@hapetoys.com
Toll-Free: 1-800-661-4142

Imported by Beleduc
Lernspielwaren GmbH in EU
Heinrich-Heine-Weg 2
09526 Olbernhau / Germany

© 2012 HaPe International, Inc.